

POSIWIRE® WS7.5 Analog, SSI or CANopen Output

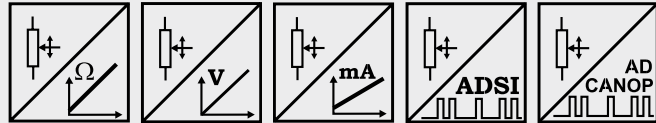

Compact industrial sensor for long ranges

- Protection class IP52
- Measurement ranges 0 ... 10000 mm to 0 ... 40000 mm
- Analog output or
A/D converted synchronous serial output (SSI) or
A/D converted CANopen output



Specifications	Outputs	Potentiometer 1 kΩ Voltage 0 ... 10 V Current 4 ... 20 mA, 2 or 3 wire Voltage or current output, programmable (PMUV/PMUI) A/D converted synchronous serial interface (SSI) A/D converted CANopen bus
	Resolution	Analog: essentially infinite ADSI16: max. 16 bit f.s. ADCANOP: 16 bit f.s.
	Linearity	Up to ±0.05% f.s.
	Sensing device	Precision potentiometer
	Material	Aluminum and stainless steel; cable: stainless steel
	Protection class	IP52
	Connection	Male 8 pin socket M12 (ADCANOP: 5 pin socket)
	Weight	Approx. 10 kg maximum
	EMC, temperature	Refer to output specification

Order code WS7.5

WS7.5 - [] - [] - [] - [] - []

Model name

Measurement range (in mm)

10000 / 20000 / 30000 / 40000

Output

R1K = Potentiometer 1 kΩ
 10V = 0 ... 10 V signal conditioner
 420A = 4 ... 20 mA signal conditioner
 420T = 4 ... 20 mA signal conditioner
 PMUV/PMUI = Programmable 0... 10 V or 4 ... 20 mA signal conditioner
 ADSI16 = A/D converted synchronous serial interface 16 bit (12 or 14 bit opt.)
 ADCANOP = A/D converted CANopen bus

Linearity

L10 = ±0.10 % option: L05 = ±0.05 % L25 = ±0.25 %

Cable fixing

M4 = M4 cable fixing
 SB0 = Cable clip

Connection

M12 = 8 pin socket M12 (ADCANOP: 5 pin)

Order code connector cable: see page 82/83

Order example: **WS7.5 - 30000 - 420T - L10 - M4 - M12**



Compact industrial sensor for long ranges

- Protection class IP52
- Measurement range 0 ... 10000 mm to 0 ... 40000 mm
- Absolute or incremental encoder



Specifications	Outputs	See order code
	Resolution for 12 bit per revolution (4096 steps/revolution)	Up to 30000: 0.073 mm; 40000: 0.088 mm
	Linearity	±0.05% f.s.; ±0.01% f.s. as option
	Sensing device	Absolute encoder / incremental encoder
	Material	Aluminum and stainless steel; cable: stainless steel
	Protection class	IP52, encoder IP64
	Connection	Depend on the encoder type: connector or bus cover
	Weight	Approx. 10 kg maximum
EMC, temperature	Refer to output specification	

Order code WS7.5

Model name

Measurement range (in mm)

10000 / 15000 / 20000 / 25000 / 30000 / 40000

Outputs

- ME = Mechanism only for installation of suitable multiturn encoders
- BK = Customer sources encoder for fitting by ASM
- LD5VC = Incremental encoder TTL compatible, inverted
- PP24VC = Incremental encoder HTL compatible, inverted
- HSSI = Absolute encoder with synchronous serial output (SSI)
- HINT = Absolute encoder with Interbus interface
- HPROF = Absolute encoder with Profibus interface
- HDEV = Absolute encoder with DeviceNet interface
- HCAN = Absolute encoder with CAN interface
- HCANOP = Absolute encoder with CANopen interface

Linearity (option)

L01 = ±0.01% f.s.

Cable fixing

- M4 = M4 cable fixing
- SB0 = Cable clip



Order code mating connector

incremental, SSI:

CONN-CONIN-12F-G

Order example: WS7.5 - 30000 - HSSI - M4

Cable forces, typical at 20 °C	Range	Max. pull-out force	Min- pull-in force
	[mm]	[N]	[N]
	10000 - 30000	8.0	4.2
	40000	7.0	3.4

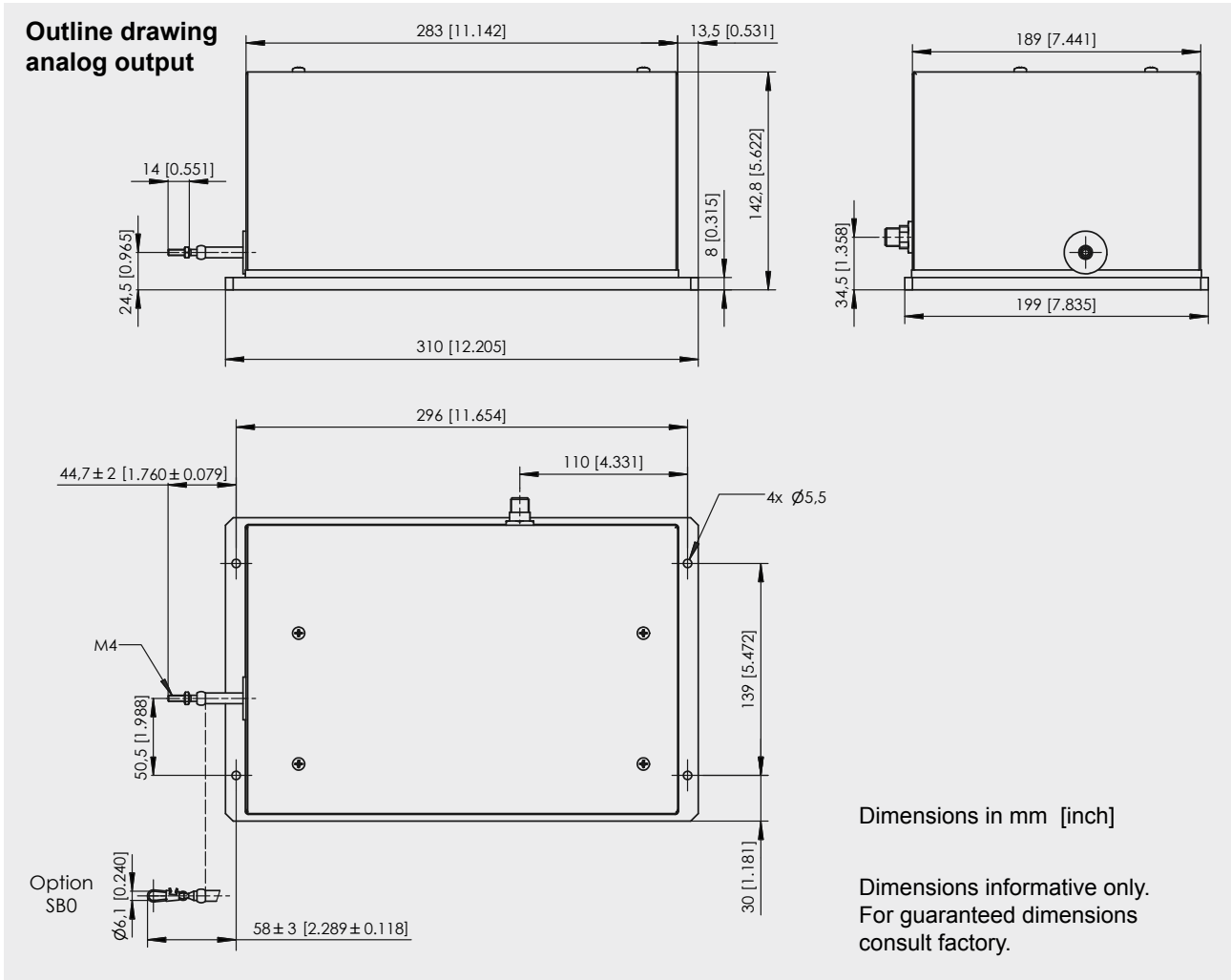

Outline drawing encoder output

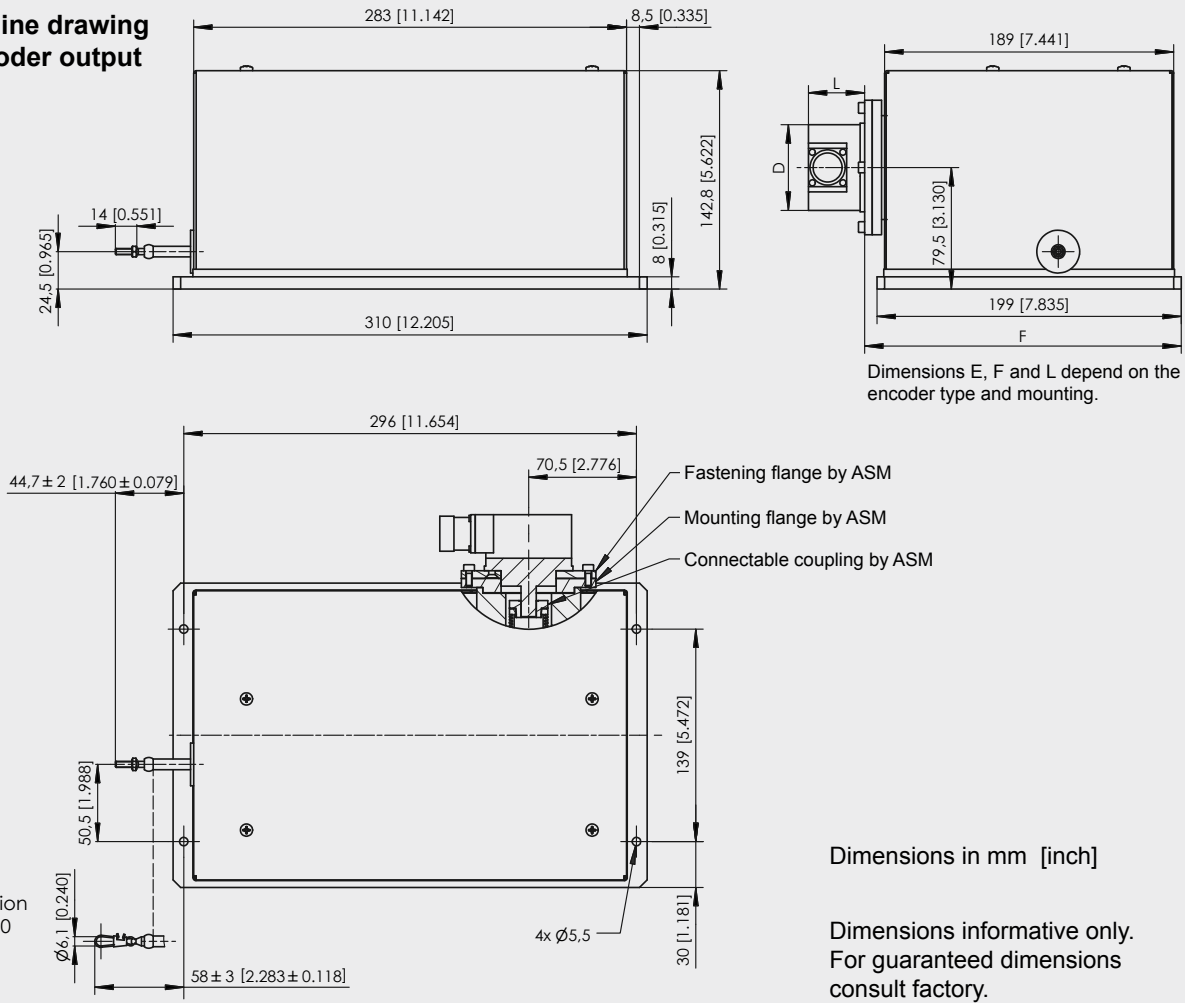

Dimensions in mm [inch]

Dimensions informative only. For guaranteed dimensions consult factory.

Output ME

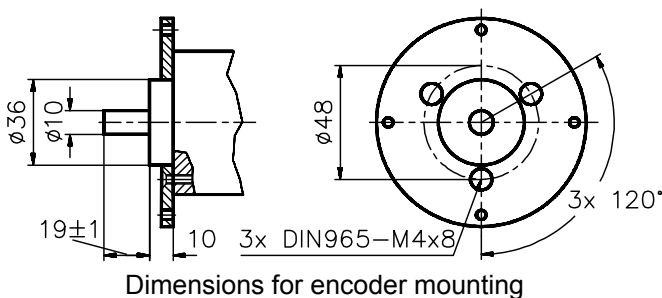

Connectable coupling in two parts (output ME)

The outer part of the coupling should be fitted to the encoder shaft. Adjust a 0.5 mm clearance between the fastening and the mounting flanges to give an initial tension on the coupling when the mounting bolts are tightened.

POSIWIRE® R1K and 10V Analog Output



Voltage divider R1K Potentiometer 	Excitation voltage	32 V DC max. at 1 kΩ (max. power 1 W)
	Potentiometer impedance	1 kΩ ±10 %
	Thermal coefficient	±25 x 10 ⁻⁶ / °C f.s.
	Sensitivity	Depends on the measuring range, individual sensitivity of the sensor is specified on the label
	Voltage divider utilization range	Approx. 3 % ... 97 %
	Operating temperature	-20 ... +85 °C

Output signals

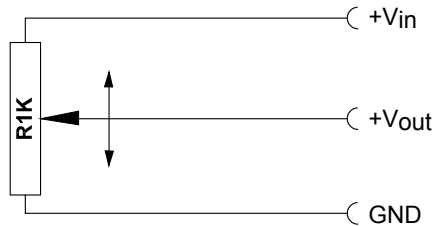

Note: The Potentiometer must be connected as a voltage divider. The input impedance of the following processing circuit should be 10 MΩ min.

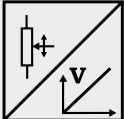
Signal conditioner 10V and 10V5 Voltage output 	Excitation voltage	18 ... 27 V DC non stabilized
	Excitation current	20 mA max.
	Output voltage	10V: 0 ... 10 V DC; 10V5: 0.5 ... 10 V DC
	Output current	2 mA max.
	Output load	> 5 kΩ
	Stability (temperature)	±50 x 10 ⁻⁶ / °C f.s.
	Protection	Reverse polarity, short circuit
	Output noise	0.5 mV _{RMS}
	Operating temperature	-20 ... +85 °C
	EMC	According EN 61326:2006

Output signals



Signal wiring	Signal name R1K	10V	Cable color	Connector pin no.
	+Vin	Excitation + +	White	1
	GND	Excitation GND	Brown	2
	+Vout	Signal +	Green	3
		Signal GND	Yellow	4

Connection

View to sensor connector

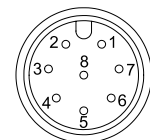

CONN-M12-8F

POSIWIRE® 420A and 420T Analog Output



Signal conditioner 420A Current output (2 wire) 	Excitation voltage	12 ... 27 V DC non stabilized, measured at the sensor terminals
	Excitation current	35 mA max.
	Output current	4 ... 20 mA equivalent for 0 ... 100 % range
	Stability (temperature)	$\pm 100 \times 10^{-6} / ^\circ\text{C}$ f.s.
	Protection	Reversed polarity, short circuit
	Output noise	0.5 mV _{RMS}
	Operating temperature	-20 ... +85 °C
	EMC	According to EN 61326:2006

Output signals

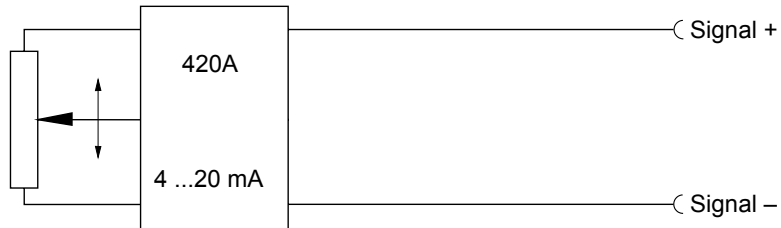

Signal conditioner 420T Current output (3 wire) 	Excitation voltage	18 ... 27 V DC non stabilized
	Excitation current	40 mA max.
	Load resistor	350 Ω max.
	Output current	4 ... 20 mA equivalent for 0 ... 100 % range
	Stability (temperature)	$\pm 50 \times 10^{-6} / ^\circ\text{C}$ f.s.
	Protection	Reverse polarity, short circuit
	Output noise	0.5 mV _{RMS}
	Operating temperature	-20 ... +85 °C
	EMC	According to EN 61326:2006

Output signals



Signal wiring	Signal name		Cable color	Connector pin no.
	420A	420T		
Signal +		Excitation +	White	1
Signal -		Excitation GND	Brown	2
		Signal +	Green	3

Connection

View to sensor
connector

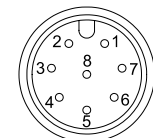

CONN-M12-8F

POSIWIRE® PMUV / PMUI Programmable Analog Output



Signal conditioner PMUV / PMUI Voltage or current output (3 wire)	Excitation voltage	18 ... 27 V DC
	Excitation current	50 mA max.
	Voltage output PMUV	0 ... 10 V
	Output current	10 mA max.
	Output load	1 kΩ min.
	Current output PMUI	4 ... 20 mA (3 wire)
	Working resistance	500 Ω max.
	Scaling	
	Activation of offset and gain adjust	Connect with excitation GND (0 V)
	Scalable range	90% max. f.s.
	Stability (temperature)	±50 x 10 ⁻⁶ / °C f.s.
Operating temperature	-20 ... +85 °C	
Protection	Reversed polarity, short circuit	
EMC	According to EN 61326:2006	

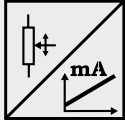
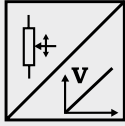

Output signals

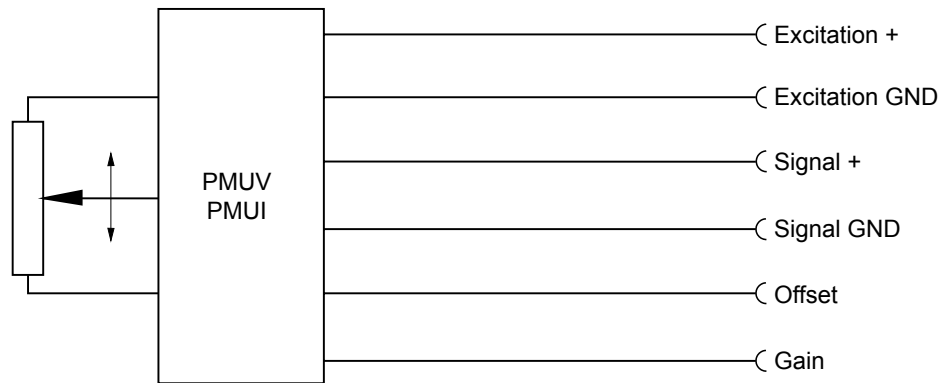

Signal name	Connector pin no.
Excitation +	1
Excitation GND	2
Signal +	3
Signal GND	4
Not used	5
Not used	6
Offset	7
Gain	8

Connection

View to sensor
connector

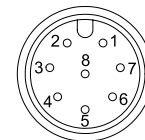

CONN-M12-8F

Signal name	Connector pin no.
Excitation +	1
Excitation GND	2
Not used	3
Not used	4
Signal +	5
Signal GND	6
Offset	7
Gain	8

POSIWIRE® ADCANOP A/D Converted CANopen Bus

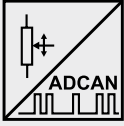

Interface ADCANOP 	Communication profile	CANopen CiA 301 V 4.02, Slave
	Encoder profile	Encoder CiA 406 V 3.2
	Error Control	Node Guarding, Heartbeat, Emergency Message
	Node ID	Adjustable via LSS
	PDO	3 TxPDO, 0 RxPDO, no linking, static mapping
	PDO Modes	Event-/Time triggered, Remote-request, Sync cyclic/acyclic
	SDO	1 server, 0 client
	CAM	2 cams
	Certified	Yes
	Transmission rates	50 kBaud to 1 MBaud, adjustable via LSS
	Nodes	127 max.
	Bus connection	M12 connector, 5 pins
	Integrated bus terminating resistor	No
Bus, galvanic isolated	No	

Specifications	Excitation voltage	18 ... 36 V DC
	Excitation current	Max. 100 mA
	Resolution	16 bit f. s.
	Measuring rate	1 kHz (asynchronous)
	Stability (temperature)	$\pm 50 \times 10^{-6}$ / °C f.s.
	Repeatability	1 LSB
	Operating temperature	-20 ... +85 °C
	Protection	Reverse polarity, short circuit
	Dielectric strength	1 kV (V AC, 50 Hz, 1 min.)
	Environment - EMC Automation	EN 61326:2004

Signal diagram

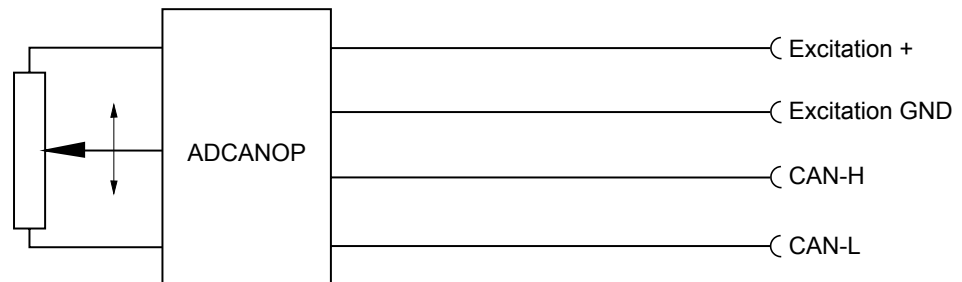

View to sensor connector

Signal wiring / connection	Signal name	Connector pin no.
	Shield	1
	Excitation +	2
	GND	3
	CAN-H	4
	CAN-L	5

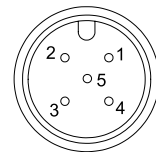

CAN bus wiring

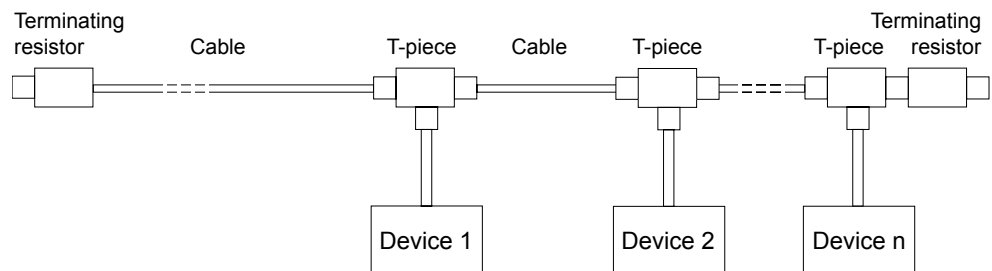

POSIWIRE® PP530 Incremental Output



Signal conditioner PP530 Incremental



Excitation voltage	5 ... 30 V DC
Excitation current	25 mA typ. (w/o load), 200 mA max.
Output frequency	200 kHz max.
Output	Linedriver, Push-Pull, CMOS, TTL- and HTL-compatible
Output current	30 mA max.
Output voltage	Depends on the excitation voltage (e.g. to obtain TTL signals the excitation voltage must be 5 V). Compatible to EIA RS422/RS485
Saturation voltage high/low	$I_a < 10 \text{ mA}$, $U_B 5 \text{ V}/24 \text{ V}$: $< 0.5 \text{ V}$ $I_a < 30 \text{ mA}$, $U_B 5 \text{ V}/24 \text{ V}$: $< 1 \text{ V}$
Stability (temperature)	$\pm 20 \times 10^{-6} / ^\circ\text{C}$ f.s. (sensor mechanism)
Operation temperature	-10 ... +70 °C
Storage temperature	-30 ... +80 °C
Transition time positive edge	$< 200 \text{ ns}$
Transition time negative edge	$< 200 \text{ ns}$
Protection	Reverse polarity, short circuit
EMC	According to EN 61326:2006

Signal diagram

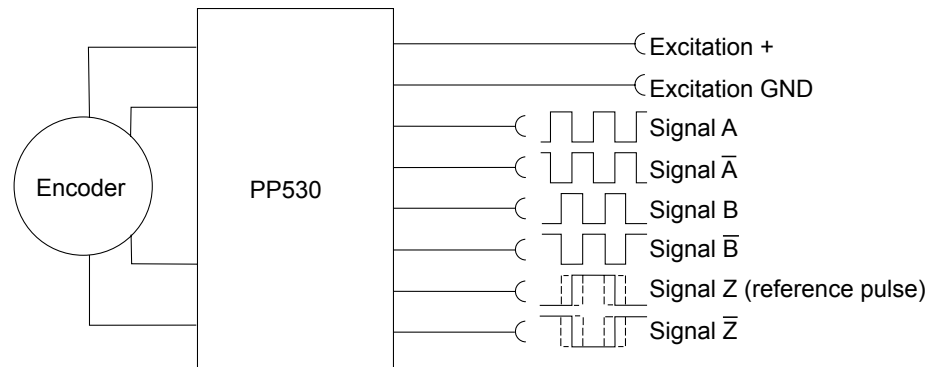

Recommended processing circuit

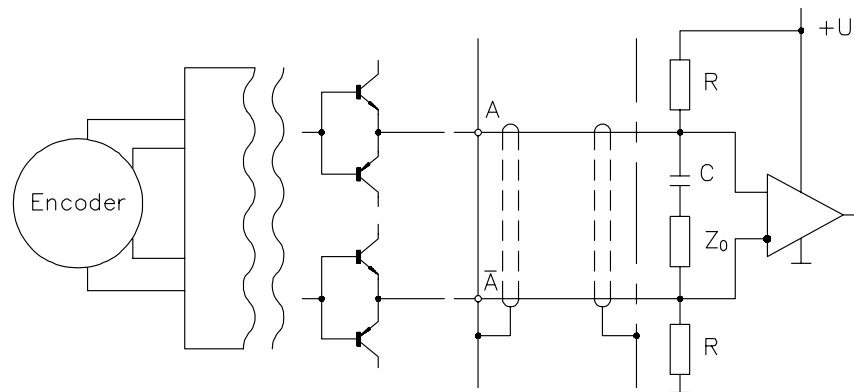

Signal wiring / connection

Output signal name	Connector pin no.
Excitation +	1
Excitation GND (0 V)	2
Signal A	4
Signal Ā	6
Signal B (A + 90°)	3
Signal B̄	5
Signal Z (reference pulse)	7
Signal Z̄	8

View to sensor connector

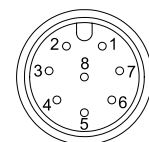

CONN-M12-8F

POSIWIRE® LD5VC and PP24VC Incremental Output

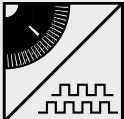

Signal conditioner LD5VC Incremental 	Interface	Line driver RS422
	Excitation voltage	5 V DC $\pm 10\%$
	Excitation current	150 mA max. w/o load
	Output frequency	300 kHz max.
	Output current	20 mA per channel
	Signal level	
	Ud High at Id=20 mA	≥ 2.5 V
	Ud Low at Id=20 mA	≤ 0.5 V
	Transition time positive edge	<100 ns
	Transition time negative edge	<100 ns
	Stability (temperature)	$\pm 20 \times 10^{-6}$ / °C f.s. (sensor mechanism)
	Operation temperature	-20 ... +85 °C
	Protection	Short circuit, overvoltage
EMC	According to EN 61326:2006	

Signal conditioner PP24VC Incremental 	Interface	Push-pull line driver (24 V-HTL)
	Excitation voltage	10 ... 30 V DC
	Excitation current	150 mA max. w/o load
	Output frequency	300 kHz max.
	Output current	100 mA per channel
	Signal level	
	Ud High at Id=20 mA, Ub=24 V	≥ 21 V
	Ud Low at Id=20 mA, Ub=24 V	≤ 2.8 V
	Transition time positive edge	<200 ns
	Transition time negative edge	<200 ns
	Stability (temperature)	$\pm 20 \times 10^{-6}$ / °C f.s. (sensor mechanism)
	Operating temperature	-20 ... +85 °C
	Protection	Reverse polarity, short circuit, overvoltage
EMC	According to EN 61326:2006	

Output signals

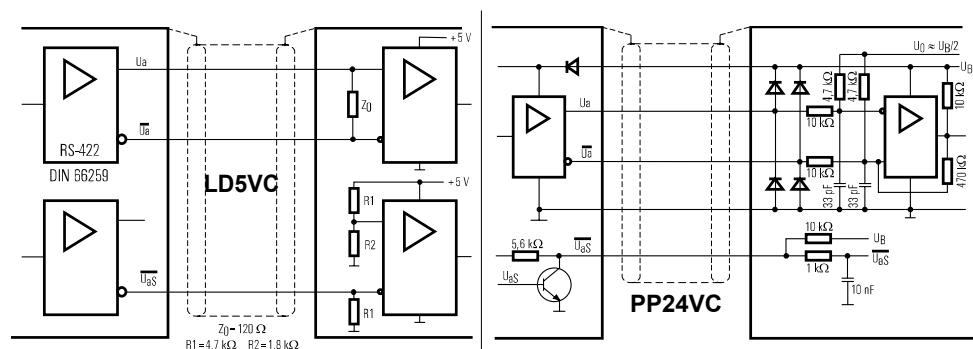
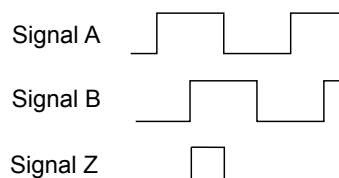

Signal name	CONN-CONIN-12F, connector pin no.
Excitation +	12
Excitation GND (0 V)	10
Signal A	5
Signal \bar{A}	6
Signal B (A + 90°)	8
Signal B	1
Signal Z (reference pulse)	3
Signal \bar{Z}	4
Fault detection signal \bar{U}_{as}	7
Shield	Housing

View to sensor connector

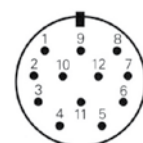

CONN-CONIN-12F

POSIWIRE®

ADSI16

A/D Converted SSI Output



- Resolution 16 bit, synchronous serial data transmission/SSI
- Optional available with 12 bit (ADSI) or 14 bit (ADSI14) resolution
- No loss of data at power down
- Easy to connect to PLC's with SSI input circuitry

Description

The sensing device of the ADSI is a precision potentiometer. The position information is given by an analog/digital converter output serialized as a data word. Data transmission takes place by means of the signals CLOCK and DATA. The processing unit (PLC, Micro-computer) sends pulse sequences which clock the data transmission with the required transfer rate. With the first falling edge of a pulse sequence the position of the sensor is recorded and stored. The following rising edges control the bit-by-bit A/D conversion, encoding and output of the data word. After a delay time the next new position information will be transmitted.

Signal conditioner ADSI16 A/D converted synchronous serial

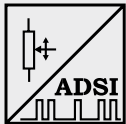

Interface	EIA RS422, RS485, short-circuit proof
Excitation voltage	11 ... 27 V DC
Excitation current	200 mA max.
Clock frequency	70 ... 500 kHz
Code	Gray code, continuous progression
Delay between pulse trains	30 µs min.
Resolution	16 bit (65536 counts) f.s.; optional 12 (ADSI) bit resp. 14 bit (ADSI14)
Stability (temperature)	±50 x 10 ⁻⁶ / °C f.s.
Operating temperature	-20 ... +85 °C
EMC	According to EN 61326:2006

Data format (train of 26 pulses)

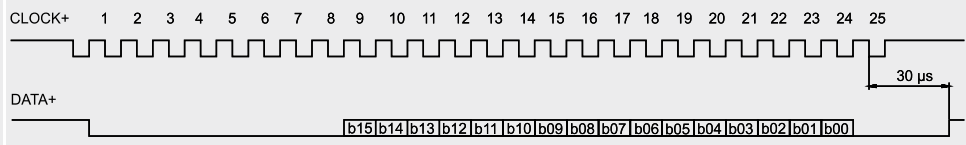

Recommended processing circuit

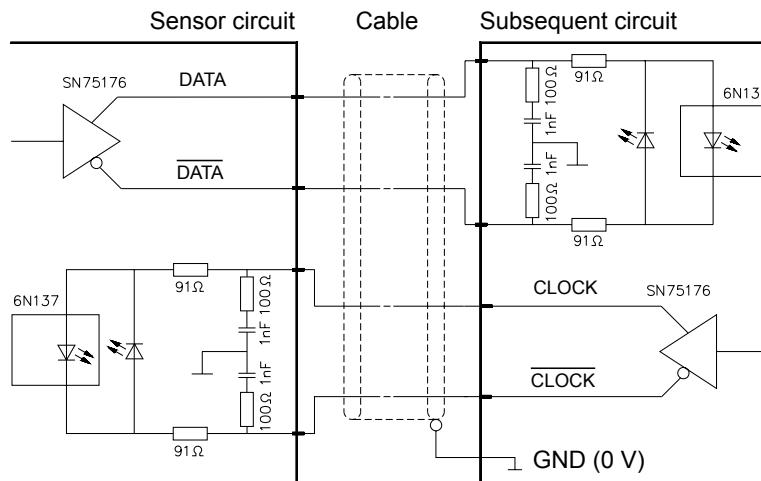

Transmission rate

Cable length	Baud rate
< 50 m	< 300 kHz
< 100 m	< 100 kHz

Note:

Extension of the cable length will reduce the maximum transmission rate.

Signal wiring

Signal name	Connector pin no.
Excitation +	1
Excitation GND (0 V)	2
CLOCK	3
$\overline{\text{CLOCK}}$	4
DATA	5
$\overline{\text{DATA}}$	6
Shield	not connected

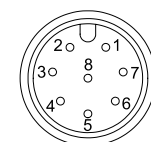

CONN-M12-8F

View to sensor
connector

POSIWIRE®

HSSI

Absolute SSI Encoder



Signal conditioner HSSI Absolute encoder synchronous serial 	Excitation voltage	10 ... 30 V DC
	Excitation current	100 mA
	Interface	Standard SSI
	Lines / drivers	Clock and data / RS422
	Code	Gray
	Resolution	12 + 12 Bit
	3 dB cutoff frequency	500 kHz
	Control input	$\overline{\text{Direction}}$
	Preset key	Zero adjustment with optical response
	Alarm output	Alarm bit (SSI option), warning bit
	Status LED	Green = OK, red = alarm
	Connection	Cable or 12 pin male socket

Data format	Resolution	Clock												
		T1	T2	T3	...	T12	T13	...	T21	T22	T23	T24	T25	T26
		Data bits												
24 bit	M11	M10	M9	...	M0	S11	...	S3	S2	S1	S0	0		

Mx = multiturn bits, Sx = singleturn bits

Transmission rate	Cable length	Baud rate	Note: Extension of the cable length will reduce the maximum transmission rate.
	< 50 m	< 400 kHz	
	< 100 m	< 300 kHz	
	< 200 m	< 200 kHz	
	< 400 m	< 100 kHz	

Signal wiring	Signal name	Color	Connector pin no.
	Excitation +	White	8
	Excitation GND (0 V)	Brown	1
	CLOCK	Yellow	3
	$\overline{\text{CLOCK}}$	Green	11
	DATA	Pink	2
	$\overline{\text{DATA}}$	Grey	10
	$\overline{\text{Direction}}$ *	Blue	5
	0 V Signal output	Black	12

* Excitation + = cw increasing code, 0 V = cw decreasing code

Connection

View to sensor
connector

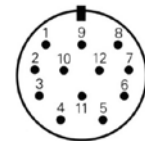

CONN-CONIN-12F

POSIWIRE®

HPROF

Absolute Profibus Encoder



Interface HPROF

Absolute encoder
Profibus



Excitation voltage	10 ... 30 V DC
Excitation current	250 mA
Interface	RS485
Protocol	Profibus DP with encoder profile C2
Resolution	12 (10 ... 14) + 12 bit
Output code	Binary
Baud rate	Automatically selected between 9,6 kBaud and 12 MBaud
Programmability	Resolution, preset, direction
Integrated special functions	Velocity, acceleration, operating time
Bus terminating resistor	Selectable via DIP switch
Connection	Bus cover with T manifold
EMC	EN 61326: class A

Signal wiring

Signal name	Cable terminal no. (bus cover)
U _B in	1
0V in	2
U _B out	3
0V out	4
B in	5
A in	6
B out	7
A out	8

POSIWIRE®

HINT

Absolute Interbus Encoder



Interface HINT Absolute encoder Interbus 	Excitation voltage	10 ... 30 V DC
	Excitation current	250 mA
	Interface	Interbus, ENCOM profile K3 (configurable), K2
	Output code	32 Bit binary
	Baud rate	500 kBaud
	Data refresh	Every 600 µs
	Resolution	12 (10 ... 14) + 12 bit
	Programmability	Direction, preset, offset, resolution
	Connection	Bus cover with T manifold
	EMC	EN 50081-2, EN 50082-2

Data format Interbus K2/K3		Differential signals (RS485) ENCOM profile K3, K2, 32 Bit, binary process data				
	DT-Format	Supi address	0	1	2	3
	(according to the Phoenix company)	Byte No.	3	2	1	0
	ID code K2	36 H (= 54 dec.)				
	ID code K3	37 H (= 55 dec.)				

Signal wiring	Signal name	Cable terminal no. (bus cover)
		U _B +
	GND	2
	DI1	3
	$\overline{DI1}$	4
	DO1	5
	$\overline{DO1}$	6
	DO2	7
	$\overline{DO2}$	8
	DI2	9
	$\overline{DI2}$	10
	RBST	11
	GND	12

POSIWIRE®
HDEV
Absolute DeviceNet Encoder



Interface HDEV Absolute encoder DeviceNet 	Excitation voltage	10 ... 30 V DC
	Excitation current	250 mA
	Interface	CAN highspeed according to ISO/DIS 11898 CAN specification 2.0 A (11 bit identifier)
	Protocol	DeviceNet according rev. 2.0, programmable encoder
	Resolution	12 (10 ... 14) + 12 bit
	Output code	Binary
	MAC-ID	Selectable via DIP switch
	Date refresh	Every 5 ms
	Baud rate	Selectable via DIP switch: 125 kBaud, 250 kBaud, 500 kBaud
	Programmability	Resolution, preset, direction
	Bus terminating resistor	Selectable via DIP switch
	Connection	Bus cover with T manifold
	EMC	EN 50081-2, EN 50082-2
Recommended transmission	Characteristic impedance	135 ... 165 Ω (3 ... 20 MHz)
	Operating capacity	< 30 pF
	Loop resistance	< 110 Ω/km
	Wire diameter	> 0.63 mm
	Wire width	> 0.34 mm ²
Transmission rate	Segment length	Kbit/s
	500 m	125
	250 m	250
	100 m	500
Signal wiring	Signal name	Cable terminal no. (bus cover)
	U _b in	1
	0V in	2
	CAN-L	3
	CAN-H	4
	Drain	5
	Drain	6
	CAN-H	7
CAN-L	8	

POSIWIRE®
HCAN/HCANOP
Absolute CAN / CANopen Encoder



Interface
HCAN/HCANOP
 Absolute encoder
 CANopen/CAN Layer 2



Excitation voltage	10 ... 30 V DC
Excitation current	250 mA
Interface	CAN highspeed according to ISO/DIS 11898
Protocol	CANopen according DS301 with encoder profile DSP406, programmable encoder according class C2
Resolution	12 (10 ... 14) + 12 bit
Output code	Binary
Data refresh	Every millisecond (selectable), on request
Baud rate	Selectable 10 up to 1000 kbit/s
Base identifier	Selectable via DIP switch
Programmability	CANopen: direction, resolution, preset, offset CAN L2: direction, limit values
Integrated special functions	CANopen: velocity, acceleration, rotary axis, limit values CAN L2: direction, limit values
Connection	Bus cover with T manifold
EMC	EN 50081-2, EN 50082-2

Signal wiring

Signal name	Cable terminal no. (bus cover)
U _B in	1
0V in	2
CAN in – (dominant L)	3
CAN in + (dominant H)	4
CAN GND in	5
CAN GND out	6
CAN out + (dominant H)	7
CAN out – (dominant L)	8
0V out	9
U _B out	10